

# ADAM-3600-C2G

## 8AI / 8DI / 4DO / 4-Slot Expansion Wireless Intelligent RTU



### Features

- High Performance CPU Cortex A8 600MHz
- Low Power DDR3L 256MB RAM
- Embedded Real-time Linux Kernel
- Domain Focused Onboard IO -8AI / 8DI / 4DO
- 4-Slot I/O Expansion
- High I/O Flexibility with 4-slot I/O Expansion
- Multiple wireless options for Zigbee/ Wi-Fi/ 3G/ 4G/ GPRS
- IEC61131-3&C Programming Language
- Modbus & DNP3 Protocol
- Operation Temperature -40~70°C
- Internal Webpage for Online Monitoring
- Periodic Logger for Data Buffering on SD card

### Introduction

The ADAM-3600-C2G is an intelligent Remote Terminal Unit with multiple wireless function capability, multiple I/O selection, wide temperature range and support flexible communication protocol for oil, Gas and Water application. In the oil, gas and water application environments the ADAM-3600 is ideal for any other remote inhospitable regions with many devices to be managed remotely.

### Features

#### Wide Array of Flexible I/Os

Wide array of on-board I/O and flexible expansion I/O modules supporting different acquisition requirements giving it a high cost performance.



#### Wireless Communication & Protocols

The ADAM-3600 simultaneously supports two mini-PCIe cards (a half-size and a full-size) for Wi-Fi/ 3G/ GPRS/ Zigbee communication which is flexible for wiring in the field. Modbus RTU/TCP and DNP3 protocol support that integrates the ADAM-3600 with more SCADA systems.



#### Wide Temperature Range

A -40~70°C operating temperature allows the ADAM-3600 to work in harsh environments and reduces the maintenance costs for customers.

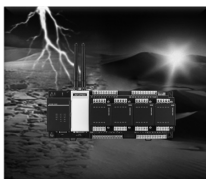

#### Remote Firmware Update

The ADAM-3600 can use a USB drive and an SD card to automatically update the firmware so there's no need to bring a computer and execute the configuration program in the field.

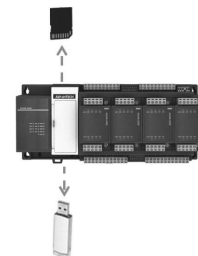

#### Intelligent Connectivity Diagnosis Manager (iCD Manager)

Remotely monitor the serial and Ethernet ports status and send the alarm information, during the communication failure, to improve the intelligent monitoring.

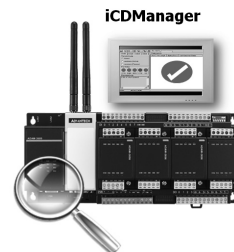

#### Node ID for Batch Configuration

Each ADAM-3600 has a node ID as its name to support batch configuration (max.64) with the configuration utility. When an alarm is displayed on the utility, customers can directly find the fault source with the node ID.

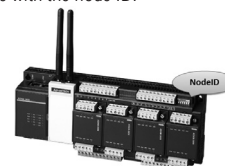

## Specifications

### Control System

- **CPU** Cortex-A8 AM3352
- **Memory** RAM 256MB  
Battery Backup RAM 32KB
- **OS** RT-Linux V3.12
- **Storage** MicroSD card / 1GB included for system  
SD card slot / Optional
- **Programming** IEC-61131-3, Linux C
- **Watchdog** Yes
- **Real-time Clock** Yes
- **Power Input** 10~30 V<sub>DC</sub>
- **Power Consumption** 24V @ 5W

### Communication

- **Protocol** Modbus/ DNP3 L2
- **Serial Port** 1 x RS232/485- DB9  
2 x RS485- Terminal Block
- **Ethernet Port** 2 x RJ-45 10/100 Mbps
- **USB Port** 1 x USB 2.0
- **VGA Port** 1 x D-SUB15
- **LED** System LEDs/ IO LEDs

### Analog Input

- **Channel** 8 differential
- **Resolution** 16-bit
- **Input Type** ±10V, ±2.5V, 0~20mA, 4~20mA
- **Isolation** 2,000 V<sub>DC</sub>

### Digital Input

- **Channel** 8
- **Input Type** Wet Contact Input (Sink)
- **Protection Voltage** +40 V<sub>DC</sub>
- **Isolation** 2,000 V<sub>DC</sub>

### Digital Output

- **Channel** 4
- **Output Type** Open Collector (Sink)
- **Rated Voltage** 8~30 V<sub>DC</sub>

### Wireless Communication(Selectable)

- **Interface** Mini-PCIe (1 x Half-Size / 1 x Full-Size)
- **Wireless Type** Zigbee- UART Signal  
Wi-Fi/3G/GPRS- USB Signal

### General

- **Certification** CE/FCC/C1D2 compliant
- **Operating Temp.** -40~70°C
- **Storage Temp.** -40~85°C
- **Humidity** 5~95%(no-condensation)
- **Mounting** DIN 35 rail/ Wall Mount

## Ordering Information

- **ADAM-3600-C2GL1A1E** 8AI/8DI/4DO/4-Slot Expansion Wireless Intelligent RTU

## Pin Assignment

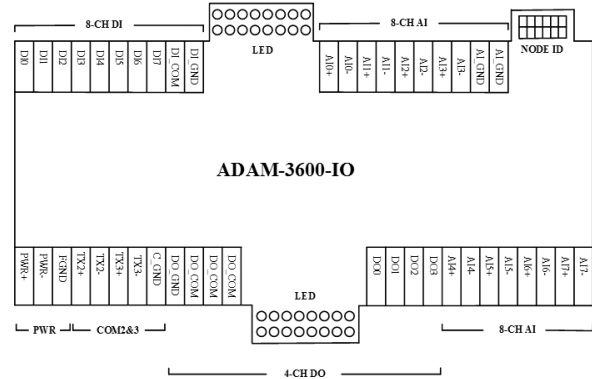

## Layout

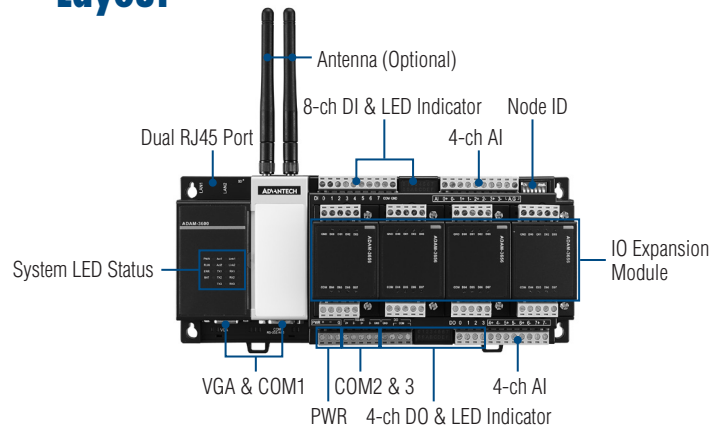

### Wi-Fi Solution

- **EWM-W150H02E** Half-size mini card. Supports 802.11bgn
- **1750006043** SMA(M) Cable, 15 cm
- **1750000318** 2dBi Antenna for testing, 11 cm

### 3G/GPRS Solution (SIM card is not included)

- **EWM-C109F601E** 6-band HSPA Cellular Module with SIM Holder
- **1750006264** SMA(F) Cable, 15 cm
- **1750005865** Dipole Antenna, 11 cm

### I/O Expansion Module Selection Table

Unit: Channels

Expansion Module	AI	T.C.	AO	DI	DO
ADAM-3617	4				
ADAM-3618		3			
ADAM-3624			4		
ADAM-3651				8	
ADAM-3656					8

## Dimensions

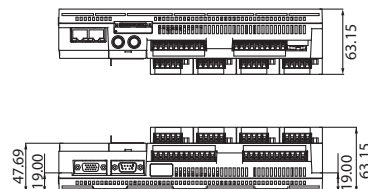
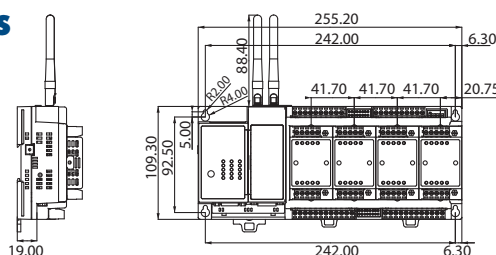

Unit: mm