

AWS-8248V

**Industrial Workstation with 15"
LCD Display**

User's Manual

Copyright

This document is copyrighted September, 2002, by Advantech Co., Ltd. All rights are reserved. Advantech Co., Ltd. reserves the right to make improvements to the products described in this manual at any time. Specifications are thus subject to change without notice.

No part of this manual may be reproduced, copied, translated, or transmitted in any form or by any means without the prior written permission of Advantech Co., Ltd. Information provided in this manual is intended to be accurate and reliable. However, Advantech Co., Ltd., assumes no responsibility for its use, nor for any infringements upon the rights of third parties which may result from its use.

Acknowledgements

AWS-8248VT, AWS-8248VTP, AWS-8248VT-T, and AWS-8248VTP-T are all trademarks of Advantech Co., Ltd. IBM and PC are trademarks of International Business Machines Corporation. MS-DOS is a trademark of Microsoft Corporation. All other brand and product names mentioned herein are trademarks or registered trademarks of their respective owners.

警告使用者

這是甲類的資訊產品，在居住的環境中使用時，可能會造成射頻干擾，在這種情況下，使用者會被要求採取某些適當的對策。

FCC Class A

This equipment has been tested and found to comply with the limits for a Class A digital device, pursuant to Part 15 of the FCC Rules. These limits are designed to provide reasonable protection against harmful interference when the equipment is operated in a commercial environment. This equipment generates, uses and can radiate radio frequency energy. If not installed and used in accordance with this user's manual, it may cause harmful interference to radio communications. Operation of this equipment in a residential area is likely to cause harmful interference, in which case the user will be required to correct the interference at his own expense.

Packing List

Before you set up the AWS-8248V, make sure that the following items have been included in your package, and that this manual is in good condition. If anything is missing or damaged, contact your dealer immediately:

- One AWS-8248V industrial workstation with 15" flat panel display
- One accessory box, including:
 - One power cord
 - One keyboard transfer cable
 - One CD-R for IC & HMI products Driver/manual
 - Flat gray cable for 3.5" HDD and slim CD-ROM
 - RS-232 cable to link touchscreen to CPU card (for -T models only)
 - Screw bag with screws-

If any of these items is missing or damaged, contact your distributor or sales representative immediately.

Additional Information and Assistance

1. Visit the Advantech web site at **www.advantech.com** where you can find the latest information about the product.
2. Contact your distributor, sales representative, or Advantech's customer service center for technical support if you need additional assistance. Please have the following information ready before you call:

- Product name and serial number
- Description of your peripheral attachments
- Description of your software (operating system, version, application software, etc.)
- A complete description of the problem
- The exact wording of any error messages

Safety Instructions

1. Read these safety instructions carefully.
2. Keep this User's Manual for later reference.
3. Disconnect this equipment from any AC outlet before cleaning. Use a damp cloth. Do not use liquid or spray detergents for cleaning.
4. For plug-in equipment, the power outlet socket must be located near the equipment and must be easily accessible.
5. Keep this equipment away from humidity.
6. Put this equipment on a reliable surface during installation. Dropping it or letting it fall may cause damage.
7. The openings on the enclosure are for air convection. Protect the equipment from overheating. **DO NOT COVER THE OPENINGS.**
8. Make sure the voltage of the power source is correct before connecting the equipment to the power outlet.
9. Position the power cord so that people cannot step on it. Do not place anything over the power cord.
10. All cautions and warnings on the equipment should be noted.
11. If the equipment is not used for a long time, disconnect it from the power source to avoid damage by transient overvoltage.
12. Never pour any liquid into an opening. This may cause fire or electrical shock.
13. Never open the equipment. For safety reasons, the equipment should be opened only by qualified service personnel.
14. If one of the following situations arises, get the equipment checked by service personnel:
 - a. The power cord or plug is damaged.
 - b. Liquid has penetrated into the equipment.
 - c. The equipment has been exposed to moisture.
 - d. The equipment does not work well, or you cannot get it to work according to the user's manual.
 - e. The equipment has been dropped and damaged.
 - f. The equipment has obvious signs of breakage.
15. **DO NOT LEAVE THIS EQUIPMENT IN AN ENVIRONMENT WHERE THE STORAGE TEMPERATURE MAY GO BELOW -20° C (-4° F) OR ABOVE 60° C (140° F). THIS COULD DAMAGE THE EQUIPMENT. THE EQUIPMENT SHOULD BE IN A CONTROLLED ENVIRONMENT.**

The sound pressure level at the operator's position according to IEC 704-1:1982 is no more than 70dB (A).

DISCLAIMER: This set of instructions is given according to IEC 704-1. Advantech disclaims all responsibility for the accuracy of any statements contained herein.

Wichtige Sicherheitshinweise

1. Bitte lesen sie Sich diese Hinweise sorgfältig durch.
2. Heben Sie diese Anleitung für den späteren Gebrauch auf.
3. Vor jedem Reinigen ist das Gerät vom Stromnetz zu trennen. Verwenden Sie Keine Flüssig-oder Aerosolreiniger. Am besten dient ein angefeuchtetes Tuch zur Reinigung.
4. Die Netzanschlussteckdose soll nahe dem Gerät angebracht und leicht zugänglich sein.
5. Das Gerät ist vor Feuchtigkeit zu schützen.
6. Bei der Aufstellung des Gerätes ist auf sicheren Stand zu achten. Ein Kippen oder Fallen könnte Verletzungen hervorrufen.
7. Die Belüftungsöffnungen dienen zur Luftzirkulation die das Gerät vor überhitzung schützt. Sorgen Sie dafür, daß diese Öffnungen nicht abgedeckt werden.
8. Beachten Sie beim Anschluß an das Stromnetz die Anschlußwerte.
9. Verlegen Sie die Netzanschlubleitung so, daß niemand darüber fallen kann. Es sollte auch nichts auf der Leitung abgestellt werden.
10. Alle Hinweise und Warnungen die sich am Geräten befinden sind zu beachten.
11. Wird das Gerät über einen längeren Zeitraum nicht benutzt, sollten Sie es vom Stromnetz trennen. Somit wird im Falle einer Überspannung eine Beschädigung vermieden.
12. Durch die Lüftungsöffnungen dürfen niemals Gegenstände oder Flüssigkeiten in das Gerät gelangen. Dies könnte einen Brand bzw. elektrischen Schlag auslösen.
13. Öffnen Sie niemals das Gerät. Das Gerät darf aus Gründen der elektrischen Sicherheit nur von autorisiertem Servicepersonal geöffnet werden.
14. Wenn folgende Situationen auftreten ist das Gerät vom Stromnetz zu trennen und von einer qualifizierten Servicestelle zu überprüfen:
 - a - Netzkabel oder Netzstecker sind beschädigt.
 - b - Flüssigkeit ist in das Gerät eingedrungen.
 - c - Das Gerät war Feuchtigkeit ausgesetzt.
 - d - Wenn das Gerät nicht der Bedienungsanleitung entsprechend funktioniert oder Sie mit Hilfe dieser Anleitung keine Verbesserung erzielen.
 - e - Das Gerät ist gefallen und/oder das Gehäuse ist beschädigt.
 - f - Wenn das Gerät deutliche Anzeichen eines Defektes aufweist.

Der arbeitsplatzbezogene Schalldruckpegel nach DIN 45 635 Teil 1000 beträgt 70dB(A) oder weiger.

DISCLAIMER: This set of instructions is given according to IEC704-1. Advantech disclaims all responsibility for the accuracy of any statements contained herein.

Contents

Chapter 1	Introduction	2
1.1	Introduction	2
1.1.1	Features:.....	3
1.2	Specifications	3
1.3	Front and rear panel layout.....	5
1.4	Dimensions.....	6
Chapter 2	System Setup.....	8
2.1	General	8
2.2	Rack mounting	9
	Figure 2.1:Rack mounting the AWS-8248	9
2.3	Panel mounting.....	10
	Figure 2.2:Panel mounting the AWS-8248.....	10
Chapter 3	Programming KBT-2002 Macro Keys	14
3.1	Introduction	14
3.2	Macro keys	14
3.3	Using Main.exe to edit Macro Key	14
3.4	Examples	15
Appendix A	Display Timing Mode and OSD	22
A.1	Supported Input Timing Modes	22
	Table A.1:Display Modes Table.....	22
A.2	OSD Operation Keypad	24
A.3	OSD function and operation.....	25
	Figure A.1:OSD menu	25
	Table A.3:OSD Functionality	26
Appendix B	Power Supply Specifications	28
B.1	Supported Input Timing Modes	28
B.1.1	Specifications.....	28
B.2	-48 V DC power supply	29
B.2.1	Specifications.....	29
	Table B.1:-48 VDC power supply output characteristics	29
	Table B.2:-48 VDC power supply DC output wire list	32
B.3	24 VDC power supply	33
	Table B.3:24VDC power supply output load range	33
B.3.1	General features.....	34
Appendix C	Optional Touchscreen.....	38
C.1	Specifications	38
C.2	Installation of Touchscreen Driver.....	39

Introduction

- Introduction
- Specifications
- Front and rear panel layout
- Dimensions

Chapter 1 Introduction

1.1 Introduction

The AWS-8248V is a 14-slot, 15" TFT LCD workstation. It is a great update to the AWS-8248 product line by offering more expansion capability, a larger LCD screen, and increased usability, all at an even more competitive price. The AWS-8248V also provides an additional major feature for users: Easy maintenance. Using three card-cages and thumb-screw fasteners, the AWS-8248V makes maintenance quick and easy. The AWS-8248V combines multiple slots and 15" LCD in a more cost effective and easier to maintain design.

Easy-to-maintain: Three card-cage and thumbscrew fasteners

The AWS-8248V's "work drawer" designed card cage conveniently slides out for easy access. These three card-cages (one drawer previously) allow add-on cards, HDD/CD-ROMs and power supplies to be easily changed or added. It only takes a few minutes to service the unit, saving time and money while reducing downtime. The thumbscrew fasteners make access fast and easy, speeding maintenance procedures.

Easy access control panel

Users can easily access the AWS-8248V's controls from the front of the unit via a sturdy protective door. Controls include LEDs and switches for power and system reset, as well as an OSD in front. The front panel also holds a 3¾" 1.44 MB FDD. The aluminum door protects controls from the environment. The door has a waterproof foam-rubber seal and retaining hand screw to securely hold it closed. In addition, the door offers protection against accidental operation of the unit's controls.

Industrial design meets harsh environment needs

In addition, the AWS-8248V also features many powerful functions that meet or exceed industrial-grade requirements. The front panel is made of aluminum, which prevents the panel from being damaged by acid, salt and other elements. The unit is also waterproof and IP65/ NEMA4 compliant. The AWS-8248V provides three mounting configurations to fit various applications: 19" rack mount, panel mounting and desktop.

1.1.1 Features:

- Low cost 15", 14-slot TFT LCD workstation, and 1024 x 768 resolution
- Three card-cage design: Easy to maintain add-on cards, CPU card and power supply.
- Two 3.5" HDDs with mobile rack drive & CD-ROM drive in back of chassis
- Equipped with the On-Screen Display (OSD) operation keypad on the front panel
- IP65/NEMA 4, Aluminum panel.

1.2 Specifications

General

- **Construction:** Heavy-duty aluminum and steel chassis
- **Disk drive housing:** Holds one 3½" FDD, one CD-ROM and two 3½" HDD (CD-ROM and HDD optional)
- **Cooling system:**
 - One 32 CFM fan (flow out) on rear panel for power supply
- **Dimensions:**
 - Width: 482 mm (19.0")
 - Depth: 450 mm (17.7")
 - Height: 356 mm (14.0")
- **Weight:** 20 kg (44 lbs)

LCD Display

- Display type: 15" TFT LCD
- Max. resolution: 1024 x 768
- Maxi. colors: 262K
- Luminance (cd/m²): 200
- Viewing angle: 100°(H), 120°(V)
- Operating temperature: 0 ~ 50°C (32 ~ 122° F)
- LCD MTBF: 50,000 hours

- Backlight lifetime: 50,000 hours
- Interface: Direct VGA
- LCD defect specification: refer to Advantech web site

Front Panel

- **Keypads:** One with 39 operating keys, one with 10 function keys and 10 programmable macro function keys
- **Keyboard connector:** Pre-wired 5-pin DIN connector with dust-protection cover on front and rear panel
- **Switches:** Reset and power on/off.

Passive backplane

- **AWS-8248VT & AWS-8248VT-T:**
14 ISA slot passive backplane
- **AWS-8248VTP & AWS-8248VTP-T:**
9 ISA / 4 PCI / 1 CPU slot passive backplane

Power supply

- **AC input:** 250 W (standard offer)
- **Input voltage:**
95 ~ 132 V_{AC} or 190 ~ 264 V_{AC} , switchable
- **Output voltage:**
+3.3V@20A, +5 V @ 27 A; +12 V @ 13 A; -5 V @ 0.3 A; -12 V @ 0.8 A
- **MTBF:** 100,000 hours
- **Safety:** UL/CSA/TUV
- **-48 V_{DC} input 250 W (optional)**
- **Input voltage:** -36 ~ -72 V_{DC}
- **Output voltage:**
+3.3V@25A, +5 V @ 30 A; +12 V @ 12 A; -5 V @ 0.5 A; -12 V @ 1.0 A
- **MTBF:** 100,000 hours

24 V_{DC} input 250 W (optional)

- Input voltage: 19 ~ 32 V_{DC}
- Output voltage:
 - +5 V @ 25 A; +12 V @ 10 A; -5 V @ 1.0 A; -12 V @ 1.0 A
- MTBF: 100,000 hours

Environmental specifications

- Operating temperature: 0 ~ 50° C (32 ~ 122° F)
- Relative humidity: 5 ~ 85% @ 40° C, non-condensing
- Vibration: 5 ~ 17 Hz, 0.1" double-amplitude displacement 17 ~ 500 Hz, 1.0 G peak to peak.

1.3 Front and rear panel layout

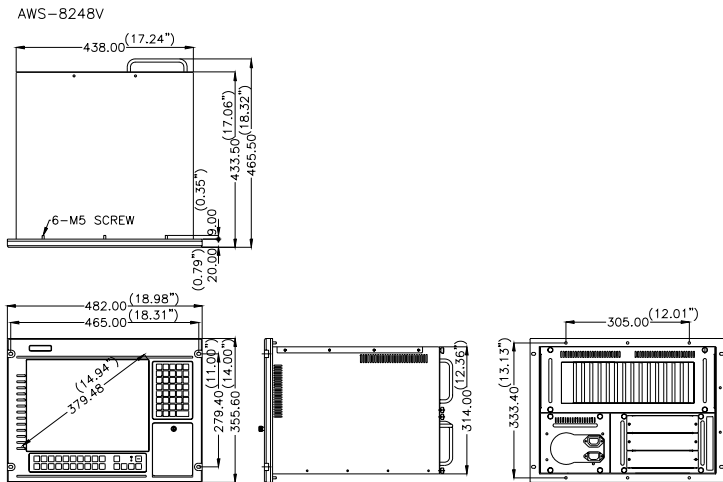

Figure 1.1: Front panel layout



Figure 1.2: Rear panel layout

1.4 Dimensions



Cutout dimensions: 450mm x 326mm
(17.72" x 12.83")

Figure 1.3: AWS-8248 dimensions

System Setup

- General
- Rack Mounting
- Panel mounting

Chapter 2 System Setup

2.1 General

When you receive your workstation you will find a backplane, power supply, and floppy disk drive already installed. Further setup of the AWS-8248V is easy. All you have to do is slide out its work drawer module, install a CPU card, optional hard disk drive and whatever additional I/O cards your application requires.

Warning!



1. Do not begin your installation until you are sure there is no power flowing within the AWS-8248V. Power must be switched off and the main power cord unplugged.

2. Every time you service the AWS-8248V, you should switch the power off and unplug the main power cord.

2.2 Rack mounting

The AWS-8248 can be mounted in a 19" rack. Ensure that all additional equipment has been installed correctly and that the cabling has been reattached. (See Fig. 2-7) Remove the screw covers on the front panel. Attach the case to the rack using screws on both sides.

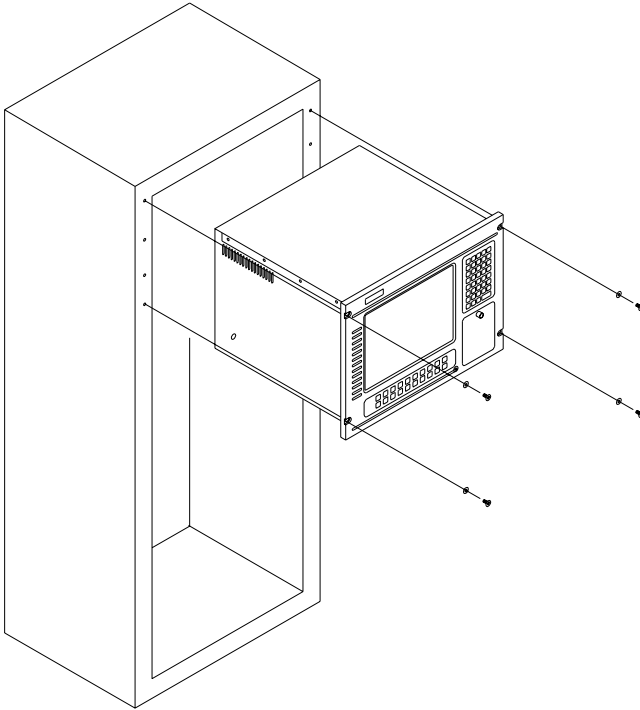

Figure 2.1: Rack mounting the AWS-8248

2.3 Panel mounting

Panel mounting the AWS-8248 is easy. Just line up the holes in the panel aperture and the holes on the panel, and then secure the AWS-8248 to the panel with the mounting bolts.

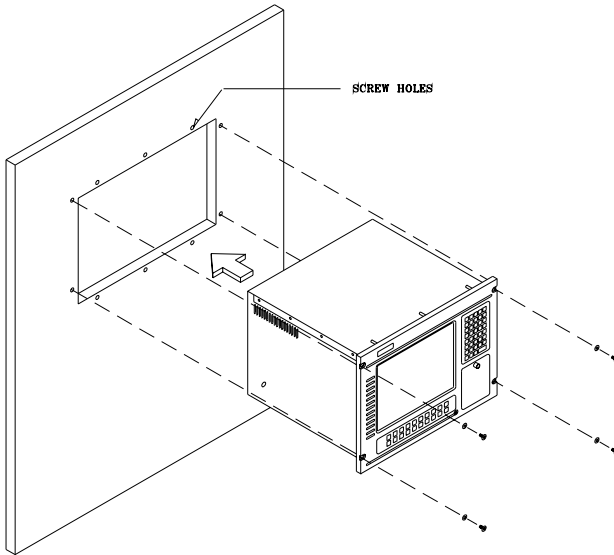

Figure 2.2: Panel mounting the AWS-8248

Programming KBT-2002 Macro Keys

- Introduction
- Macro Keys
- Using Main.exe to edit Macro Key
- Examples

Chapter 3 Programming KBT-2002 Macro Keys

3.1 Introduction

The KBT-2002 is equipped with programmable function keys (macro keys) that greatly enhances the operating interface. Macros, which are far more powerful than batch files; automate the most commonly used input sequences. They extend their functional reach within application programs.

3.2 Macro keys

Macro keys (SF1 , SF2 ,...SF10)

Ten programmable macro keys are located on the front panel of the workstation.

Macro keys (SF11 , SF12 ,...SF30)

These twenty programmable macro keys are customized models. If your workstation doesn't have these twenty keys, you do not need to edit SF 11 to SF 30 when using the utility program, Main.exe, to edit the macro keys.

The limitation of editing the macro keys

When editing the macro keys, the number of characters is limited to 78. Every ten macro keys are defined as one block; there are three blocks in total. The size of each block is limited under 256 bytes. Please refer to the next section for editing the macro keys.

3.3 Using Main.exe to edit Macro Key

First, copy all the files to your hard disk and/or make a backup disk. Take a look at the content of the utility disk; please find the .pad file that corresponds to your workstation, for example, AWS8420.pad. Remember this file name, because you will need it to edit the macro keys.

There is an example within the subdirectory of the utility disk. Go into this subdirectory and look for a .txt file that corresponds to your workstation, for example, AWS8420.txt. You can use this file under the macro key edit program to practice.

Note 1: The keyboard translator utility main.exe program can be run under DOS mode only.

Note 2: The following windows illustrations are examples only. You must follow the instruction and pay attention to the instructions which appears on you screen.

3.4 Examples

Boot your workstation and enter the DOS command. Key in main.exe and press the enter key. You will see the following screen.

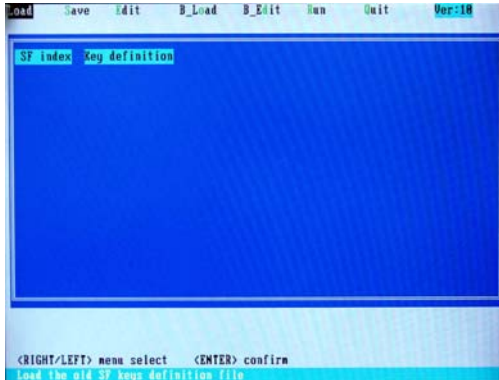

Choose Load in the function and press the enter key. Key in the file name that you edited in this program before. To practice, you can choose, for example, the AWS8420.txt in the example in the utility disk. After reading the file, press Esc key to leave this mode.

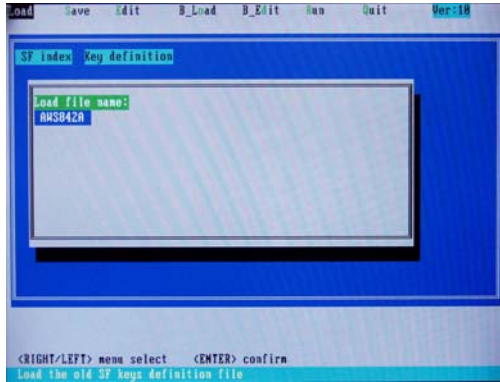

Whether you have loaded the old file or not, choose Edit in the main menu and press enter to go into the edit mode. You can see the operating guide at the bottom of the screen. Use the up/down arrow keys to move the cursor, and page up/page down keys to change pages. These keys help you to choose the macro keys that you want to edit. The SF01, SF02, and etc represent the macro keys. They are called the macro key number. After picking the macro keys you want to edit, press the enter key to go into a sub screen.

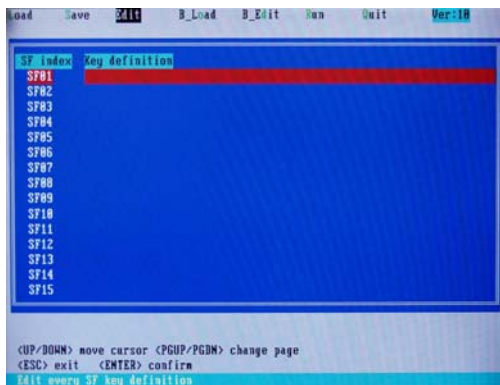

n this sub screen, you can key in any character string that you want to see when pressing this macro key, or any signs. You can also key in the names of the function keys of the keyboard; but please add a [] sigh. The number characters you key in should be under 78. After editing, press Esc key to go back to the edit mode, then you can choose other macro keys to edit. If there is no SF 11, SF1 2,...SF30 on your workstation, please ignore and do not edit them. Upon completing the edit, press ESC key to leave the edit mode. You can see that there is no red bars on the macro keys you've edited. Choose Save in the main menu and press enter key. You will see a sub-screen like this. Please key in a file name; the total number of the character used should be under 7. After keying in the file name, press Enter; the system will save it with .txt and leave the Save mode.

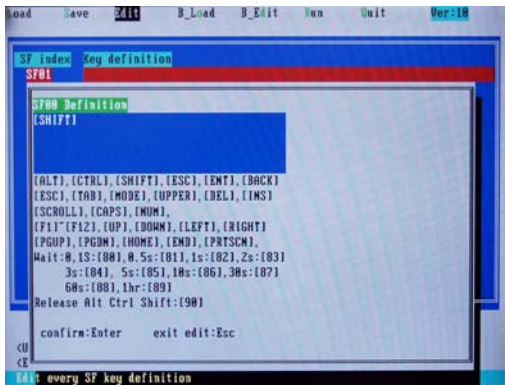

Choose Run in the main menu, and press Enter to go into the Run (programming) mode. You will see a sub-screen for upper key setting OFF= Press both character and upper key in the same time ON= Press upper key. Then key the character for upper layer. Press the upper key again for the lower layer PS: some membrane keypad has Upper indicator (light on=upper status)

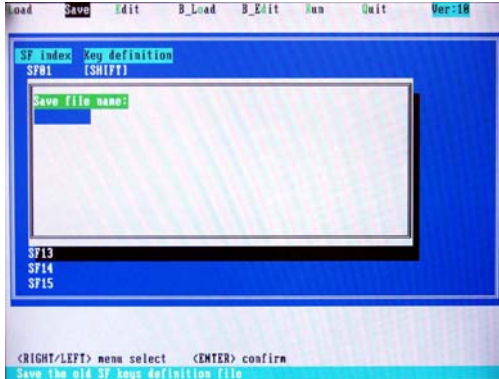

After setting the upper key, press Enter. Choose if you need the beep sound when you press the macro keys. OFF = no beep sound ON = with beep sound

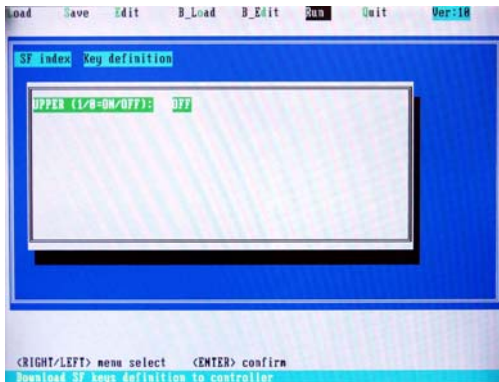

After the beep sound setting, press Enter and you will be asked to key in a .pad file name. Please refer to chapter 1.3. Do not use any other file names other than that of this workstation, or character definition errors might arise!

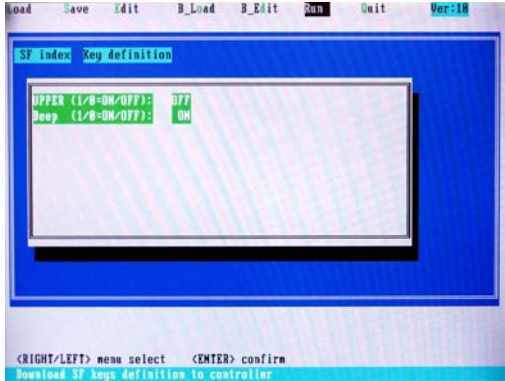

After keying the file name, press Enter, The system will start to read the data in the file together with the data in the .txt file that you just edited and save to the keyboard translator board of this workstation.

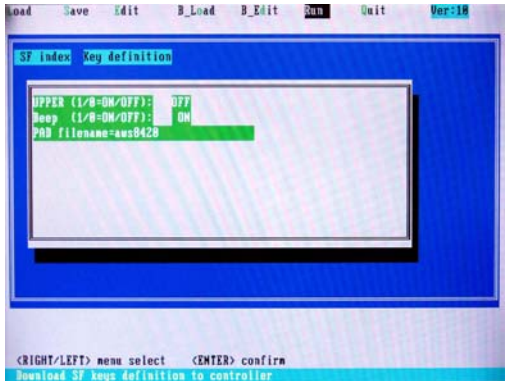

After the system finished the programming, you will see a sub-screen that tells you to repeat the process again or press Esc to leave the Run mode.

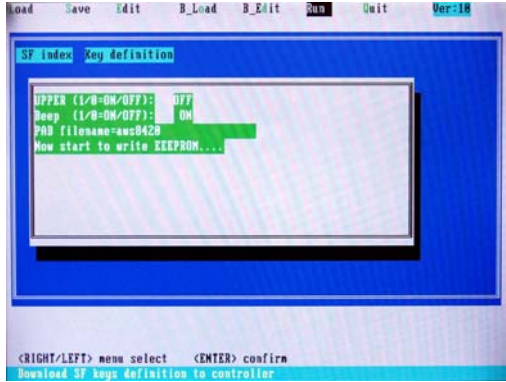

Note: There might be transition error when the connection cable between the CPU card and the keyboard translator is too long. If the error occurs, please turn off the workstation and use a shorter cable, then reboot the workstation and run the main.exe program again.

Display Timing Mode & OSD

- Supported input timing modes
- OSD operation keypad
- OSD function and operation

Appendix A Display Timing Mode and OSD

A.1 Supported Input Timing Modes

The following nineteen kinds of timings have already been programmed in this module. The input synchronous signals are automatically recognized.

Table A.1: Display Modes Table

Chroma 2325 Timing No.	Resolution	HSYNC / KHz (+/-)	VSYNC / Hz (+/-)	PIXEL RATE / MHz	REMARK
#008	VGA 640 * 350	31.469 (+)	70.087 (-)	25.175	
#011	VGA 640 * 400	31.469 (-)	70.087 (+)	25.175	
#013	VGA 640 * 480	31.469 (-)	59.941 (-)	25.175	
#016	VGA 720 * 350	31.469 (-)	70.087 (-)	28.322	
#019	VGA 720 * 400	31.469 (-)	70.087 (+)	28.322	
#032	VESA 640 * 400	37.861 (-)	84.136 (+)	31.500	* #034 and #074
#033	VESA 640 * 480	37.861 (-)	72.810 (-)	31.500	* #076
#034	VESA 720 * 400	37.736 (-)	84.045 (+)	36.000	* #032 and #074
#035	VESA 800-5	35.156 (+)	56.250 (+)	36.000	* #066
#036	VESA 800-6	37.879 (+)	60.317 (+)	40.000	
#037	VESA 800-7	48.077 (+)	72.188 (+)	50.000	
#038	VESA 1024-6	48.363(-)	60.004 (-)	65.000	* #067
#039	VESA 1024-7	56.476 (-)	70.069 (-)	75.000	

Table A.1: Display Modes Table

Chroma 2325 Timing No.	Resolution	HSYNC / KHz (+/-)	VSYNC / Hz (+/-)	PIXEL RATE / MHz	REMARK
#008	VGA 640 * 350	31.469 (+)	70.087 (-)	25.175	
#041	VESA 1024-75	60.023 (+)	75.029 (+)	78.750	
#042	VESA 1024-85	68.677(+)	84.996(+)	94.500	
#066	OAK 800 * 600	35.156(+)	56.160 (+)	36.000	* #035
#067	OAK 1024 * 768	48.077 (+)	59.797 (+)	36.000	* #038
#074	640 * 400	37.861 (-)	85.081 (+)	31.500	* #032 and #034
#075	720 * 400	37.927 (-)	85.038 (+)	35.500	
#076	640 * 480	37.861 (-)	72.810 (-)	31.500	* #033
#077	640 * 480	37.500 (-)	75.000 (-)	31.500	
#078	640 * 480	43.269 (-)	85.008 (-)	36.000	
#079	800 * 600	46.875 (+)	75.000 (+)	49.500	
#080	800 * 600	53.674 (+)	85.062 (+)	56.250	

PS1: This table was tested by Chroma 2325 Pattern Generator. Other resolutions such as VSYNC And HSYNC are not recommended.

PS2: * Can't occur in the same time.

Note 1: Even if the preset timing is entered, a little adjustment of the functions such as Horizontal period, CLK-delay and display position, are required. The adjusted values are memorized in every preset number.

Note 2: This module recognizes the synchronous signals with near preset timing of the frequency of the HS and Vsync, even in the case that the signals other than the preset timing that were entered.

Note 3: Because adjustments may not fit, such as differing magnifying ratios or, in the case that you use it except for the display timing that was preset.

A.2 OSD Operation Keypad

The OSD keypad, including the six keys and two color indicators, is designed as the OSD operation interface.

The six keypad functions are in Table A-2.

Table A.2: Keypad functions

Auto	Press this button to execute auto adjustment process
Select	Press to show the OSD screen or select an item to change its setting
◀ ▶	To move between items or increase or decrease setting
Exit	To exit from the current setting in OSD function
On/OFF	Turns display backlight ON and OFF

Note: The green light means that the COMMON board detects the input signal and ends output signal to LCD panel.

A.3 OSD function and operation

Auto-adjustment process or to adjust manually:

1. Press [Sel] button to display the OSD Menu shown below.
2. Press ◀ or ▶ button to scroll to the desired menu option.
3. Press [Sel] button to select the menu option.
4. Press ◀ or ▶ button to adjust the setting.
5. Press [Exit] button or wait until time out to save changes and exit the menu or sub-menu.



Figure A.1: OSD menu

Table A-3 is the OSD menu hierarchy and function description.

Table A.3: OSD Functionality			
Main Menu	Sub Menu	Sub Menu	Functionality
Brightness	Reset Brightness		Adjust display brightness
Contrast	Contrast	Reset Contrast	Adjust RGB contrast simultaneously
	R Sub Contrast	Reset R Contrast	Adjust R contrast
	G Sub Contrast	Reset G Contrast	Adjust G contrast
	B Sub Contrast	Reset B Contrast	Adjust B contrast
Position	H. Size	Reset H. Size	Adjust clock number per line
	Clock Phase	Reset Clock Phase	Adjust phase of ADC sample clock
	H. Position	Reset H. Position	Adjust display image left or right
	V. Position	Reset V. Position	Adjust display image up or down
Information			Display input mode information
All Reset			Reset all parameters to factory default setting

Power Supply Specification

- 250 watt power supply
- -48 VDC power supply
- 24 VDC power supply

Appendix B Power Supply Specifications

B.1 Supported Input Timing Modes

The AWS-8248 off-line switching power supply is ideal for use in workstations. It has been designed to meet UL, CSA and TUV safety standards. It has been tested and found to comply with the limits for a Class B digital device, pursuant to Part 15 of the FCC Rules. These limits are designed to provide reasonable protection against harmful interference when the equipment is operated in a commercial environment.

B.1.1 Specifications

Input

- **Input range:** AC 115/230 V
- **Input frequency:** AC 115 V/60 Hz, 230 V/50Hz
- **Input current:** AC 115 V/10A, 230 V/5A
- **Efficiency:** >65% @ full load, nominal line
- **EMI/RFI:** FCC Part 15 Class B; CISPR 22
Class B

1. Maximum continuous DC output power shall not exceed 250 W
2. +3.3 V and +5 V total O/P power should not exceed 175 W
3. -12 V and -5 V max. total combined current is 0.8 A
4. M.T.B.F: 150K hours min. at max. load and 25° C ambient conditions

B.2 -48 V_{DC} power supply

The following specifications describe the physical and electrical characteristics of a 310 W, four output, DC to DC switching power supply housed in a standard size PS/2 casing.

B.2.1 Specifications

Input voltage: 36~72V (continuous operation)

-48 VDC (normal operation)

Input current: 10 A max. @ -48 V_{DC} input

Inrush current: 5 A max. @ -48 V_{DC} input

Efficiency: 70% min. @ full load and normal line voltage

Output characteristics:

Output voltage	Max Load	Total Max. Output
+3.3V	25A(Max. 150W)	250W
+5V	30A(Max. 150W)	
+12V	12A	
-5V	.5A	
-12V	1A	
+5V sb	1A	

Table B.1: -48 V_{DC} power supply output characteristics

Note 1: *Total regulation tolerance includes temperature change, warmup drift and dynamic load.*

Note 2: *Ripple and noise were measured differentially at the power supply using loads that were each shunted by at least a 0.1 m F ceramic disc capacitor and a 10 m F electrolytic capacitor, each capacitor having a bandwidth up to 20 MHz.*

Overshoot (resistive load):

Any output overshoot when the power is turned on does not exceed 10% of the nominal output voltage.

Output power: Maximum continuous: 310 W

Power good and power fail signals (optional):

When the power is turned on, the power good signal will activate 100 to 500 ms after all output DC voltages are operating within their respective regulation limits.

The power fail signal will activate at least 1 ms before the +5 V output voltage falls below its regulation limit.

Short circuit protection:

A short circuit placed on any output to ground is shut down. When the short circuit conditions have ceased to exist, power will then be recycled to restart the power supply.

Over-current protection:

The power supply will shut down all the DC outputs when any output is overloaded beyond its current limit or beyond its nominal line voltage limit. When the over-current conditions have ceased to exist, power will then be recycled to restart the power supply.

Current limit ranges: 5 V:	32 ~ 45 A
12 V:	13 ~ 20 A
-12 V:	6 ~ 12 A
-5 V:	1.5 ~ 3 A

Over-voltage protection:

The power supply will shut down all the DC outputs when any output maximum voltage limit is exceeded. When the over-voltage conditions have ceased to exist, power will then be recycled to restart the power supply.

Voltage limit ranges: 5 V:	6.25 ±0.75 V
12 V:	14 ±1 V
-5 V:	-6.25 ±0.75 V
-12 V:	-14 ±1 V

Reset time:

When the power supply has automatically shut down, and the short circuit, over-current and/or over-voltage conditions have ceased to exist, power will be automatically recycled to restart the power supply within 3 seconds of such return to normal conditions.

No load start:

When the power supply is switched on but with no load connected, the power supply does not get damaged, and it is still completely safe for users.

Transient response:

Dynamic load change: $\pm 50\%$ of maximum rating load

Recovery time: 500 μs max.

Reliability:

Mean time between failures (MTBF): 100,000 hours minimum

Operating temperature: 0 ~ 50° C

Storage temperature: -40 ~ 60° C

Operating and storage humidity: 10 ~ 95% RH

Operating altitude: sea level ~ 15,000 ft

Storage altitude: sea level ~ 50,000 ft

International Standards Compliance

Safety: UL 1950
CSA 22.2 No. 234
TUV EN 60950

EMI: FCC Part 15 Subpart J Class B

DC Output wire list

All DC output cables use UL 1007 type wires.

Connector	Output	Color	Wire #AWG	Length (mm)	Housing	Terminal
P8-1	PG	Orange	18	300 +30/-10	BURNDY GTC 6P-1 or equivalent	BURNDY DCK 18-2TR9 or equivalent
P8-2	+5 V	Red	18			
P8-3	+12 V	Yellow	18			
P8-4	-12 V	Blue	18			
P8-5	COM	Black	18			
P8-6	COM	Black	18			
P9-1	COM	Black	18	300 +30/-10	BURNDY GTC 6P-1 or equivalent	BURNDY DCK 18-2TR9 or equivalent
P9-2	COM	Black	18			
P9-3	-5 V	White	18			
P9-4	+5 V	Red	18			
P9-5	+5 V	Red	18			
P9-6	+5 V	Red	18			
PE-1	+12 V	Yellow	18	300 +30/-10	AMP 480424-0 or equivalent	AMP 61314 or equivalent
PE-2	COM	Black	18			
PE-3	COM	Black	18			
PE-4	+5 V	Red	18			
PF-1	+5 V	Red	20	150 +30/-10	AMP 171822-4 or equivalent	AMP 170262-1 or equivalent
PF-2	COM	Black	20			
PF-3	COM	Black	20			
PF-4	+12 V	Yellow	20			
PA-1	+12 V	Yellow	18	300 +30/-10	AMP 480424-0 or equivalent	AMP 61314 or equivalent
PA-2	COM	Black	18			
PA-3	COM	Black	18			
PA-4	+5 V	Red	18			
PB-1	+12 V	Yellow	18	150 +30/-10	AMP 480424-0 or equivalent	AMP 61314 or equivalent
PB-2	COM	Black	18			
PB-3	COM	Black	18			
PB-4	+5 V	Red	18			

Table B.2: -48 V_{DC} power supply DC output wire list

B.3 24 V_{DC} power supply

This is a DC to DC switching mode power supply with a 24 V_{DC} input.

Input voltage:+19 ~ +32 V_{DC} (normal operation)

Input current:16 A max. @ +24 V_{DC} input

Inrush current:10 A max. @ +24 V_{DC} input

Output load range:

Output voltage	Max Load	Total Max. Output
+3.3V	25A(Max. 150W)	250W
+5V	30A(Max. 150W)	
+12V	12A	
-5V	.5A	
-12V	1A	
+5V sb	1A	

Table B.3: 24V_{DC} power supply output load range

At the factory, the +5 V output was set between 5.00 and 5.10 V, while other outputs were simultaneously set at 60% of their respective rated loads.

The -5 V and -12 V outputs can be used at their respective rated loads. The +5 V output should carry a load of at least 4 A.

Output power:

Total DC continuous power does not exceed 250 W. Each output should be able to operate continuously under its maximum load.

Ripple and noise:

Peak to peak ripple and noise for each output is less than 1% of each output's respective voltage. Measurements were performed with a 15 MHz bandwidth limited oscilloscope, and each output was terminated with a 0.47 μ F capacitor. V

Line regulation:

The output line regulation for each output is less than $\pm 1\%$, when measured at each output's respective rated load and under $\pm 10\%$ changing input voltage conditions.

Load regulation:

The values for each of the following output numbers were obtained by changing each output load $\pm 40\%$ from the 60% rated load, whilst simultaneously keeping all other outputs at 60% of their respective rated loads.

Power good signal:

When the power is turned on, the power good signal will activate 100 to 500 ms after all output DC voltages are operating within their respective regulation limits.

Power fail signal:

This will activate at least 0.5 ms before any of the output voltages fall below their respective regulation limits.

B.3.1 General features**Efficiency:**

65% typical when measured at nominal input and rated load.

Input protection:

Protection against wrong polarity if the +24 V input voltage is mistakenly reversed.

Output protection:

If for some reason the power supply fails to control itself, the built-in over-voltage protection circuit will shut down the outputs to prevent damage to external circuits. The trip point of the crowbar circuit is approximately 5.7 ~ 7.0 V. The power supply will go into hiccup mode under short circuit or overload conditions, and will recover automatically when such conditions cease to exist.

Environmental specifications

Operating temperature: 0 ~ 45° C

Storage temperature: -40 ~ 75° C

International standards compliance

Safety: UL 1950 D3

CSA 234

TUV EN 60950

Touchscreen (optional)

- Installation of touchscreen driver

Appendix C Optional Touchscreen

C.1 Specifications

Electrical

Operating Voltage:	3.3 to 5 VDC typical
Sheet Resistance:	220 ± 30% W/square
Linearity:	+/- 1.5% full scale linearity error in either direction.
Insulation Resistance:	> 20 MΩ @ 25 VDC.

Optical

Total light Transmission: 68% typical (> 66% @ 550 nm test)

Environmental

Operating Temperature Range:	-20°C to +50°C, ambient humidity
Storage Temperature High:	+70°C, 500 hours at ambient humidity
Storage Temperature Low:	-40°C, continuous at ambient humidity
Accelerated Aging:	100 hours continuous exposure at 60°C/95% RH
	Thermal Shock: 25 cycles (one cycle is 30 min. dwell alternating from -40°C to +85°C with less than 10 min. transfer time).

Mechanical

Activation Method:	Gloved or ungloved finger Delrin or plastic stylus (no metal) with 1mm radius full hemispherical tip
Activation Force:	< 70g average with non-metal stylus < 90g average with 5/8" diameter sili cone finger

Durability

Point Activation Life:	1 Million activations on a single point with a 5/8" diameter silicone finger with a 350g load at 2 Hz
Character Activation Life:	>100,000 characters written within a 20mm x 20mm

C.2 Installation of Touchscreen Driver

The touchscreen for the AWS-8248 Series provides drivers for use with MS-DOS, Windows 3.1, 95, 98, NT, 2000, XP. For the detailed touchscreen driver installation procedure, please refer to the Utility CD ROM path \AWS-8248\Touchscreen\Penmount 9000

