

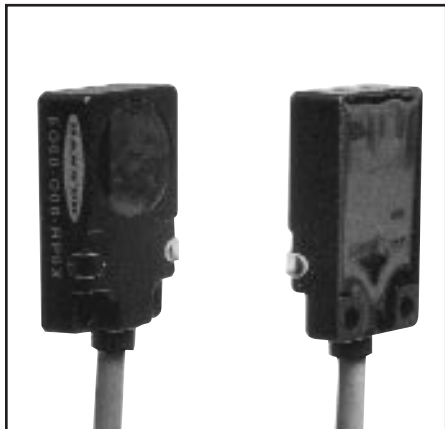

Q08 Series Opposed-Mode Sensors

Low-profile infrared sensors in rugged metal housings

Q08 Series Opposed-Mode Sensor Features



- Miniature right-angle dc photoelectric sensors in rugged die-cast metal housings
- Powerful 20" range
- Ultra-thin; only 8 mm (0.3") deep
- Pulse synchronization between emitter and receiver produces extremely high noise immunity
- Totally self-contained; 10 to 30V dc operation
- Easy mechanical alignment
- Circuitry is completely sealed and epoxy-encapsulated; rated IP67 and NEMA 6
- Select models with NPN (sinking) or PNP (sourcing) output
- Select light operate or dark operate models
- 3-wire hookup; output load capacity to 150 milliamps
- LED indicators for Power ON and Output ON; Output indicator may be used for alignment
- 2 m (6.5') standard integral cable length; 9 m (30') cable is also available

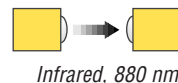
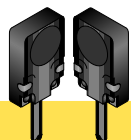

Infrared, 880 nm

Q08 Series Opposed-Mode Emitter (S) and Receiver (E) Models – Order Separately

Models*	Range	Cable	Supply Voltage	Output Type	Excess Gain	Beam Pattern
S060-Q08 EO60-Q08-AN6X	510 mm (20")	2 m (6.5')	10-30V dc	Receiver: NPN/LO		
S060-Q08 EO60-Q08-RN6X				Receiver: NPN/DO		
S060-Q08 EO60-Q08-AP6X				Receiver: PNP/LO		
S060-Q08 EO60-Q08-RP6X				Receiver: PNP/LO		

*NOTE: 9 m (30') cables are available by adding suffix "W/30" to the model number of the cabled version (e.g., S060-Q08 w/30).

WARNING: SEE SAFETY USE WARNING ON BACK PAGE

Q08 Series Opposed-Mode Sensors

Q08 Series Opposed-Mode Sensor Overview

Banner model Q08 emitters and receivers are very small, rugged, and powerful infrared opposed-mode (“through-beam”) sensor pairs contained within die-cast metal housings *only 8-mm deep*. Sensing range is 20". Q08 emitters and receivers are totally self-contained and are powered from 10 to 30V dc.

Q08 opposed sensor pairs are ideal for sensing of parts on small conveyors and for other similar short-range opposed-mode sensing uses. The size of these powerful compact sensors makes them especially useful in applications with limited space.

A synchronizing wire connecting the emitter and receiver “gates” the receiver to look for a light signal only during the instant when the emitter sends a light pulse from its infrared LED. This produces exceptionally high immunity to electrical noise and false signals. The modulated infrared sensing beam, along with polysulfone lenses on both the emitter and receiver, result in extremely high immunity to interference from visible ambient light.

Model Q08 receivers have a solid-state output capable of switching loads of up to 150 mA dc, continuous. Four output types are offered: NPN sinking/light operate, NPN sinking/dark operate, PNP sourcing/light operate, and PNP sourcing/dark operate. See the table of available models on page 1. A light-operate output conducts when the receiver sees the emitter’s pulse-synchronized light source. A dark-operate output conducts when the receiver does not see the emitter’s pulse-synchronized light source.

A green LED indicator on both the emitter and receiver units, visible from the front and left side of the sensor, lights whenever dc power is applied (see figure 1). A yellow LED (receiver units only), visible from the front and the right side of the receiver, lights whenever the receiver’s output circuit is conducting.

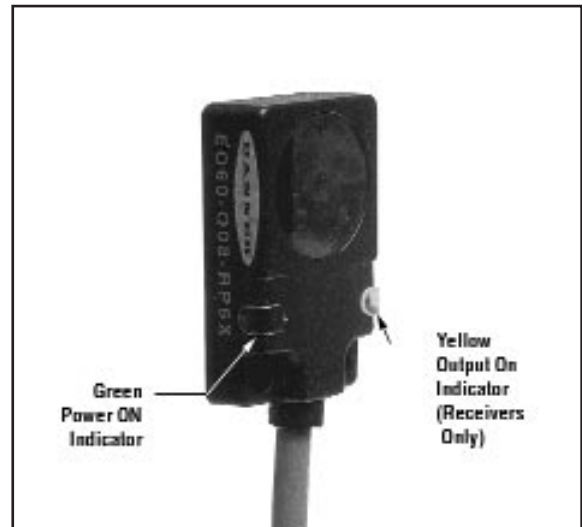

Figure 1. Q08 Series Opposed-Mode emitter and receiver features

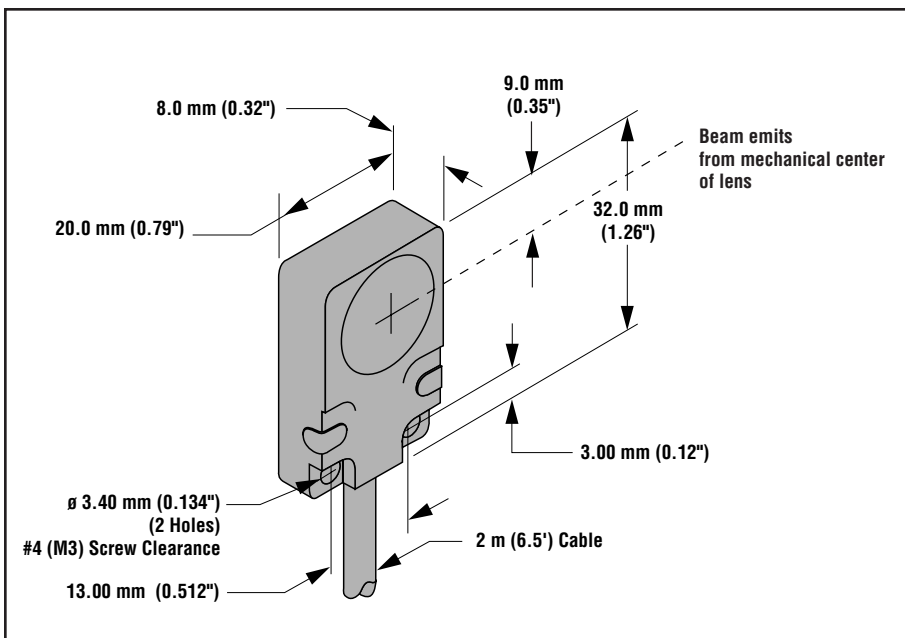



Figure 2. Q08 Opposed-Mode Sensor dimensions (attached cable version only)

Q08 Series Opposed-Mode Sensors

Q08 Series Opposed-Mode Sensor Specifications

Supply Voltage and Current	10 to 30V dc at 30 mA total maximum; 15 mA for emitter, 15 mA for receiver (exclusive of load); 10% maximum ripple
Supply Protection Circuitry	Protected against reverse polarity
Output Configuration	Solid-state dc output, with four output types available: NPN sinking/light operate PNP sourcing/light operate NPN sinking/dark operate PNP sourcing/dark operate Light operate outputs conduct when the receiver sees the emitter's pulse-synchronized light source; Dark operate outputs conduct when the receiver does not see the emitter's pulse-synchronized source.
Output Rating	150mA maximum, continuous Off-state leakage current is 100 microamps at 30V dc On-state saturation voltage is < 200 millivolts at 10 mA dc and < 1 volt at 150 mA dc
Output Protection Circuitry	Protected against false pulse on power-up and continuous overload or short circuits of outputs. Overload trip point \geq 220 mA, typical, at 20°C.
Output Response Time	1 millisecond ON and OFF independent of signal strength
Repeatability	200 microseconds (0.2 milliseconds), independent of signal strength
Indicators	Two LED indicators: Green: Lights to indicate dc power ON Yellow: Lights (except opposed emitters) when sensor output is conducting (in "light" condition for light operate models; in "dark" condition for dark operate models)
Construction	Black epoxy-painted die-cast zinc housing, polysulfone thermoplastic lens with two through-mounting holes to accommodate M3 (#4) hardware
Environmental Rating	Meets NEMA standards 1, 2, 4, 6, 12 and 13; IEC IP67
Connections	PVC-jacketed 2 m (6.5') or 9 m (30') cable. Cable is 4.0 mm (0.16") in diameter.
Operating Conditions	Temperature: 0° to +50° C (+32° to +122°F) Maximum relative humidity: 90% at 50°C (non-condensing)
Certifications	

Q08 Series Opposed-Mode Sensor Hookups

Emitter and NPN (Sinking) Receiver

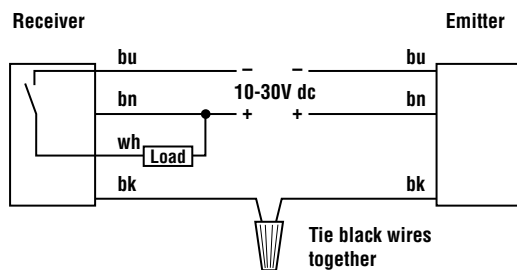

Emitter and PNP (Sourcing) Receiver

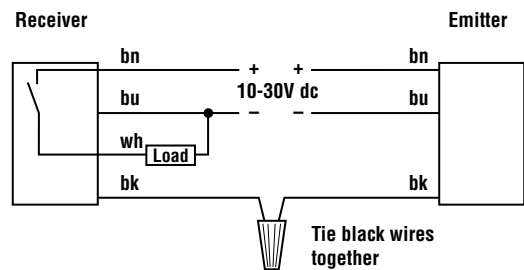

Q08 Series Opposed-Mode Sensors



WARRANTY: Banner Engineering Corporation warrants its products to be free from defects for one year. Banner Engineering Corporation will repair or replace, free of charge, any product of its manufacture found to be defective at the time it is returned to the factory during the warranty period. This warranty does not cover damage or liability for the improper application of Banner products. This warranty is in lieu of any other warranty either expressed or implied.



WARNING . . . Not To Be Used for Personnel Protection

Never use these products as sensing devices for personnel protection. Doing so could lead to serious injury or death.

These sensors do NOT include the self-checking redundant circuitry necessary to allow their use in personnel safety applications. A sensor failure or malfunction can cause either an energized or de-energized sensor output condition. Consult your current Banner Safety Products catalog for safety products which meet OSHA, ANSI and IEC standards for personnel protection.