



T8 Series Diffuse-Mode Sensor Features

- Extremely small package self-contained miniature sensors
- 10 to 30V dc operation
- Visible red sensing beam
- Choose dark or light operate models
- Choose models with NPN (sinking) or PNP (sourcing) output
- 3-wire hookup; output load capacity to 50 mA
- Choice of integral cable or quick-disconnect connector

T8 Series Overview

T8 Series self-contained miniature sensors are designed for precision sensing in small areas previously accessible only to remote sensors and fiber optic cable. Typical applications include mounting on compact conveyors, packaging machines, circuit board and semi-conductor wafer handling equipment, document handling equipment, robot end-effectors, feeder bowls, between the rollers of narrow conveyors, or as replacements for damaged small-diameter inductive proximity sensors. The T8's sensing range is many times greater than that of the typical 8 mm diameter inductive sensor. And it provides a low-cost alternative to diffuse (bifurcated) fiber optic sensors.

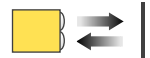

Visible red, 680 nm

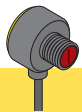

T8 Series Diffuse-Mode Sensors

Models*	Range	Cable	Supply Voltage	Output Type	Excess Gain	Beam Pattern
T8AN6D50 T8AN6D50Q	50 mm (2")	2 m (6.5') 3-Pin Pico pigtail QD	10 to 30V dc	NPN Light Operate		
T8RN6D50 T8RN6D50Q		2 m (6.5') 3-Pin Pico pigtail QD		NPN Dark Operate		
T8AP6D50 T8AP6D50Q		2 m (6.5') 3-Pin Pico pigtail QD		PNP Light Operate		
T8RP6D50 T8RP6D50Q		2 m (6.5') 3-Pin Pico pigtail QD		PNP Dark Operate		
T8AN6D100 T8AN6D100Q	100 mm (4")	2 m (6.5') 3-Pin Pico pigtail QD		NPN Light Operate		
T8RN6D100 T8RN6D100Q		2 m (6.5') 3-Pin Pico pigtail QD		NPN Dark Operate		
T8AP6D100 T8AP6D100Q		2 m (6.5') 3-Pin Pico pigtail QD		PNP Light Operate		
T8RP6D100 T8RP6D100Q		2 m (6.5') 3-Pin Pico pigtail QD		PNP Dark Operate		

*9 m (30') cables are available by adding suffix "W/30" to the model number of any cabled sensor (e.g., T8AN6D50 W/30). A model with a QD connector requires a mating cable (see page 3).

T8 Series Diffuse Mode

T8 Series Specifications

Supply Voltage and Current	10 to 30V dc (10% maximum ripple) at less than 25 mA (exclusive of load)
Supply Protection Circuitry	Protected against reverse polarity and transient voltages
Output Configuration	SPST solid-state switch Choose NPN (current sinking) or PNP (current sourcing) models Choose light operate (N.O.) or dark operate (N.C.) models
Output Rating	50 mA maximum Off-state leakage current: < 1 microamp at 24V dc On-state saturation voltage: < 0.25V at 10 mA dc; < 0.5V at 50 mA dc
Output Protection Circuitry	Protected against false pulse on power-up and continuous overload or short circuit of outputs Overload trip point \geq 100 mA
Output Response Time	1 millisecond ON and OFF (NOTE: 150 millisecond delay maximum on power-up: output does not conduct during this time)
Repeatability	160 microseconds
Indicator	Red LED: On when light is sensed
Construction	Reinforced polycarbonate/ABS alloy housing, acrylic window
Environmental Rating	IEC IP67; NEMA 6
Connections	2 m (6.5') attached cable: three #28 ga stranded conductors with PE insulation; PVC outer cable jacket; or 3-pin Pico-style pigtail quick-disconnect fitting. QD cables are ordered separately.
Operating Conditions	Temperature: -20° to +55°C (-4° to +131°F) Maximum Relative Humidity: 80% at 50°C (non-condensing)
Application Notes	Optional mounting bracket is available (page 3). Reinforced polycarbonate/ABS alloy 8 mm threaded nut (included).

T8 Series Sensor Hookups

Sensors with NPN Outputs
Cabled hookup

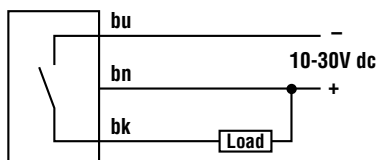

Sensors with PNP Outputs
Cabled hookup

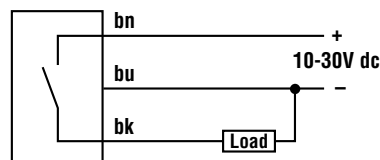

Quick-Disconnect hookup

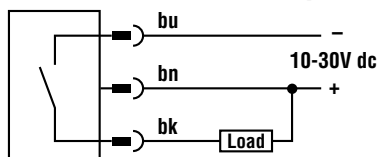

Quick-Disconnect hookup

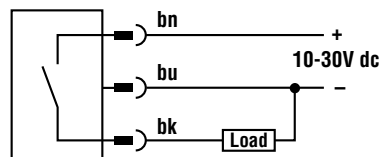

T8 Series Diffuse Mode

T8 Series Diffuse Mode Sensor Dimensions

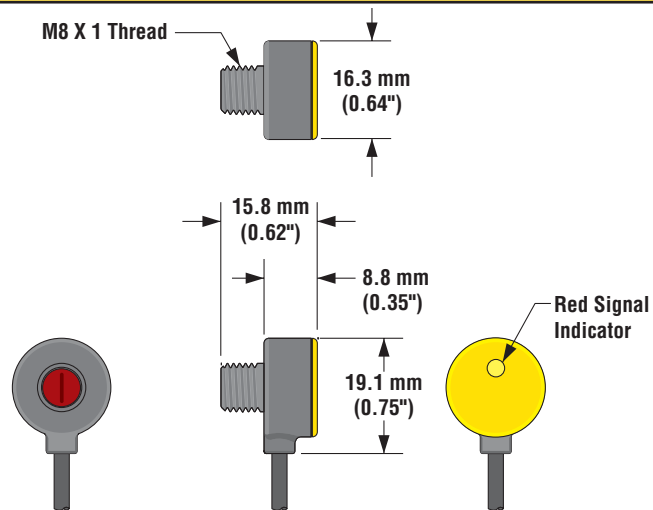

Accessories

Quick-Disconnect (QD) Cables

Style	Models	Length	For Use With	Dimensions	Pin-Out (Female View)
3-pin Pico Style Straight	PKG3M-2 PKG3M-9	2 m (6.5') 9 m (30')	All T8 Series sensors with model suffix "Q".	<p>34.7 mm (1.37") M8 x 1 9.6 mm (0.38")</p>	<p>Black Wire Blue Wire Brown Wire</p>

T8 Series Diffuse Mode

T8 Series Mounting Brackets

SMB8MM

- Right-angle bracket
- 300 series stainless steel

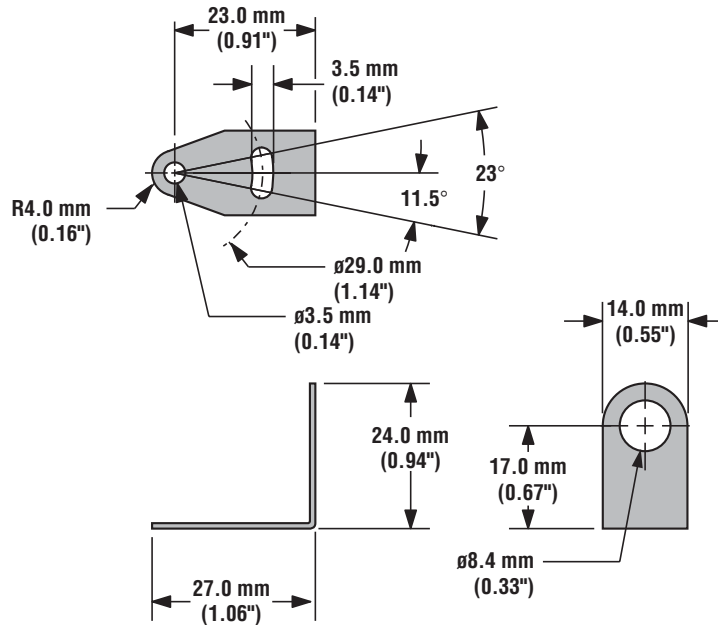

WARNING . . . Not To Be Used for Personnel Protection

Never use these products as sensing devices for personnel protection. Doing so could lead to serious injury or death.

These sensors do NOT include the self-checking redundant circuitry necessary to allow their use in personnel safety applications. A sensor failure or malfunction can cause either an energized or de-energized sensor output condition. Consult your current Banner Safety Products catalog for safety products which meet OSHA, ANSI and IEC standards for personnel protection.

WARRANTY: Banner Engineering Corp. warrants its products to be free from defects for one year. Banner Engineering Corp. will repair or replace, free of charge, any product of its manufacture found to be defective at the time it is returned to the factory during the warranty period. This warranty does not cover damage or liability for the improper application of Banner products. This warranty is in lieu of any other warranty either expressed or implied.